



# Retro

## MUTFAK ŐEĐİ KULLANMA KILAVUZU





**KULLANMADAN ÖNCE MUTLAKA OKUYUNUZ**

## **GÜVENLİK UYARILARI**

Tercihinizi PORLAND RETRO MUTFAK ŞEFİ'nden yana kullandığınız için teşekkür ederiz. Ürünümüz size uzun süre sorunsuz hizmet vermek için tasarlanıp üretilmiştir.

Bu kullanma talimatları cihazın düzgün ve güvenli bir şekilde kullanılabilmesi için düzenlenmiştir.

***Elektrikli cihaz kullanırken, aşağıdakiler de dahil olmak üzere temel güvenlik önlemlerine her zaman uyulmalıdır.***

- Cihazı, elektrik kablosunu veya fişini suya veya başka bir sıvıya daldırmayın.
- Cihazın fişi ve priz arasındaki uyumsuzluk durumunda, prizi uygun olan başka bir tip priz ile kalifiye bir personel ile değiştirin.





- Tüm elektrikli cihazlar gibi özellikle küçük çocukların bulunması durumunda, cihazın kullanımı konusunda sađduyulu ve ihtiyatlı olun.
- Őebeke elektrik geriliminin cihazın veri plakasında belirtilen ile uyumlu olup olmadıđını kontrol edin. Cihazı yalnızca minimum 10A kapasiteye sahip ve verimli bir toprak hat çekilmiş akım prizine takın. Üretici, tesisatın toprak hat yetersizliđine bađlı olası kazalardan sorumlu tutulamaz.
- Açık havada kullanmayın.
- Cihaz max. 2000m yüksekliklerde, ev içinde şahsi kullanım için tasarlanmıştır.
- Cihaz kullanılmadığında fişini elektrik hattından çıkarın ve cihazı kapatın. Cihazı gereksiz yere elektrikte bırakmayın.
- Cihazın kullanıcı tarafından yapılan günlük bakımı ve temizliđi dışındaki tüm işlemlerin yetkili bir servis tarafından gerçekleştirilmesi gerekmektedir.





- Güvenliđiniz için yalnız cihaz için tasarlanmış olan üreticinin aksesuar ve yedek parçalarını kullanın.
- Cihaz düzgün çalışmıyor veya hasar görmüşse cihazı kullanmayın. Bu durumda yetkili servise başvurun.
- Cihazı su muslukları, lavabolar ve ısı kaynaklarının uzađında, düz bir çalışma zeminine yerleřtirin.
- Cihazı asla 0°C veya daha düşük sıcaklıklara ulaşabilen ortamlara kurmayın.
- Bu cihaz sadece ev ve ofis kullanımı için tasarlanmıştır. Farklı amaç için kullanmak cihaza zarar verebilir.
- Bağlantıyı kesmek için Açma/Kapama tuşundan “**Kapalı**” konumuna getirin, fişini duvar prizinden çekin. Daima prizi tutun ve fişini çekin, asla kabloyu çekmeyin.
- Herhangi bir cihaz çocuklar tarafından veya çocukların yakınında kullanıldığında yakın gözetim gereklidir.





## **Dikkat!**

**Bu uyarıya uygun hareket edilmemesi, yaralanmaya veya cihazın hasar görmesine neden olabilir.**

**Üretici uygunsuz, hatalı ve mantıksız kullanımlardan kaynaklanabilecek olası hasarlardan sorumlu tutulamaz.**

- Bu cihaz, 8 yaşından büyük çocuklar ve kısıtlı fiziksel, algısal veya zihinsel kapasiteye sahip veya deneyim ve bilgisinden yoksun kişiler tarafından, dikkatle gözetim altında tutulmaları ve cihazın güvenli bir şekilde kullanımı ve olası risklerle ilgili bilgilendirilmeleri kaydıyla kullanılabilir. Çocuklar cihazla oynamamalıdır. Cihazın temizlik ve bakımı, 8 yaşından küçük veya gözetimsiz çocuklar tarafından yapılmamalıdır. Cihazı ve kablosunu, 8 yaşının altındaki çocukların ulaşmayacağı yerlerde saklayın.





Retro





# KULLANIM KURALLARI



Bu uyarıya uygun hareket edilmemesi, yaralanmaya veya cihazın hasar görmesine neden olabilir.

Üretici uygunsuz, hatalı ve mantıksız kullanımlardan kaynaklanabilecek olası hasarlardan sorumlu tutulamaz.

- Cihazı su muslukları, lavabolar ve ısı kaynaklarının uzağında düz bir çalışma zeminine yerleştirin.
- Cihazı asla 0°C veya daha düşük sıcaklıklara ulaşabilen ortamlara kurmayın (eğer su donarsa cihaz hasar görebilir).
- Cihazı tezgah üzerine yerleştirdikten sonra, cihazın yüzeyleri ile yan ve arka duvarlar arasında yaklaşık 5 cm boşluk kaldığını ve kahve makinesinin üzerinde en az 20 cm serbest alan bulunduğunu kontrol edin.
- Kullanılmadığında ve temizlemeden önce fişi prizden çekin. Parçaları takıp çıkarmadan ve cihazı temizlemeden önce soğumaya bırakın.





- Bu cihaz sadece ev ve ofis kullanımı için tasarlanmıştır. Farklı amaç için kullanmak cihaza zarar verecektir.
- Bağlantıyı kesmek için Açma/Kapama tuşundan “Kapalı” konumuna getirin, fişi duvar prizinden çekin. Daima prizi tutun ve fişi çekiniz, asla kabloyu çekmeyin.
- Mikserinizin ana gövdesini KESİNLİKLE su ya da başka bir sıvıya daldırmayın. Herhangi bir şekilde ıslanmış olan cihazınızın fişini derhal prizden çekin.
- Mikserinizin fişini, işiniz bittiğinde, aksesuarlarını takıp çıkarmadan, bakım ve temizliğini yapmadan önce MUTLAKA prizden çekin.
- Mikserinizin çırpma ve yoğurma uçları ile boş kaptı veya dışarıda çalıştırmayın. Cihazınız zarar görebilir.
- Mikseriniz çalışırken, hareketli parçalarına dokunmaktan kaçının. Ellerinizi, saçlarınızı, giysinizi ve herhangi bir aleti yaklaştırmayın.





- Mikserinize aşırı miktarda gıda koymayın.
- Mikserinizi gıda harici parlayıcı, yanıcı maddeleri karıştırmak için kullanmayın.
- Bağlantıyı kesmek için Açma/Kapama tuşundan “Kapalı” konumuna getirin, fişi duvar prizinden çekin. Daima prizi tutun ve fişi çekiniz, asla kabloyu çekmeyin.
- Cihazın bazı parçaları çalışırken sıcaktır, bu nedenle elinizle dokunmayın. Yalnızca kulpları veya topuzları kullanın.
- Cihazla oynamadıklarından emin olmak için çocuklar gözetim altında tutulmalıdır.



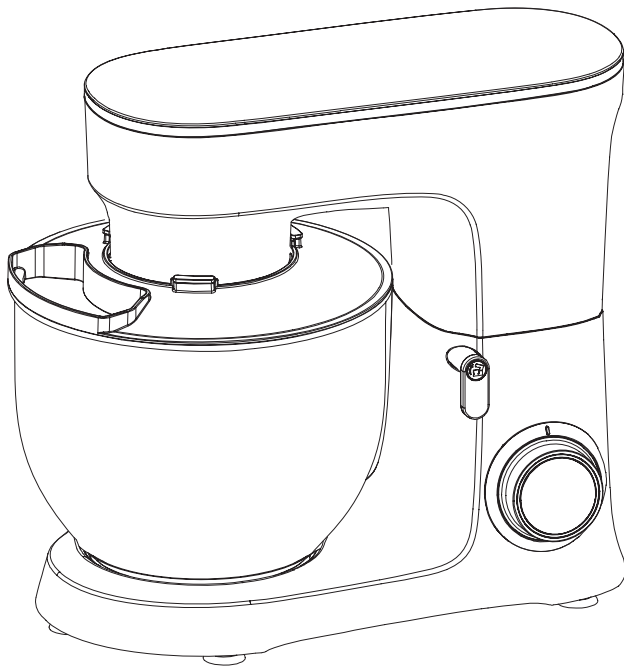



Retro





# CİHAZIN TANITIMI

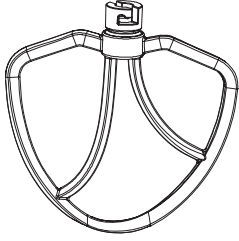

## APARAT KULLANIMLARI;

**Karıştırıcı:** Normal ile ağır arası karışımlar için kullanın: Kekler, bisküviler, kremalı şekerli karışımlar, hamur işleri gibi.

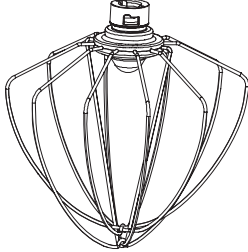

**Çırpıcı:** İçerisine hava girmesi gereken karışımlar için kullanın: Yumurtalar, yumurta beyazı, ağır krema gibi.

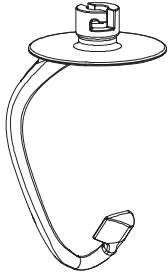



**Hamur Yoğurucu:** Mayalama hamurunu karıştırıp, yoğurmak için kullanın: Ekmekler, kekler, sandviç ve poğaçalar.

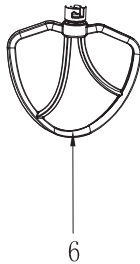
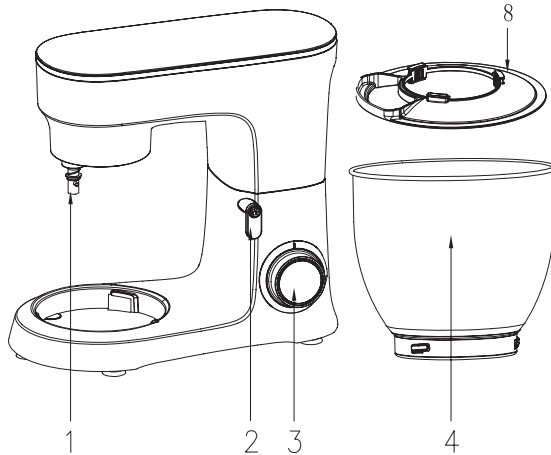





Aksesuarlar	GÖRSEL	HIZ KADEMESİ	SÜRE (min)	MAX	OPERATION METHOD
HAMUR YOĞURUCU		1-3	3-5	1000g UN + 538g SU	30 saniye boyunca 1.Kademe Hız, 30 saniye boyunca 2. Kademe Hız ve ardından 2 ila 4 dakika boyunca 3. Kademe Hız
KARIŞTIRICI		2-4	3-10	600g UN + 840g SU	20 Saniye boyunca 2.Kademe Hız, 2 DK. 40 saniye boyunca 4.kademe hız
ÇİRPİCİ		5-6	3-10	3 Yumurta akı (min)	3 DK. boyunca 5. Veya 6. Kademe Hız



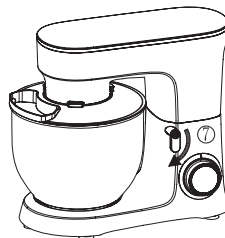
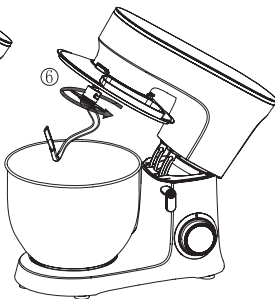
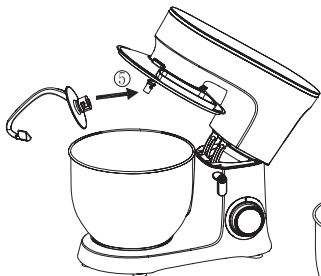
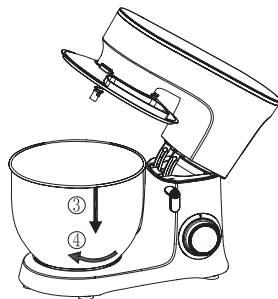
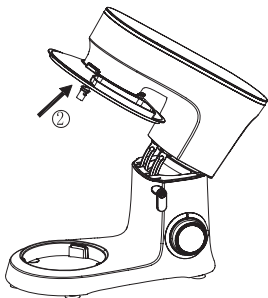



## STAND MİKSERİNİZİ KULLANMA

### İlk kullanımdan önce

Standlı mikserin tüm parçaları ilk kullanımdan önce iyice temizlenmelidir.

- Stand mikserinizi düz, temiz ve kuru bir yüzeye yerleştirin ve ardından cihazın fişini prize takın.
- Motor gövdesini yukarı doğru hareket ettirmek için motor gövdesi kaldırma düğmesini ok yönünde (sol tarafa) çevirin.
- Kullanmak istediğiniz aparatı motor gövdesinin altında bulunan aparat girişine yerleştirin ardından saat yönünde çevirin.
- Karıştırma haznesini takın ve daha sonra cihaz üzerinde gösterilen ok yönünde çevirip, kilitlendiğine emin olun.





- Motor gövdesi kaldırma düğmesini saat yönünde döndürerek motor gövdesini aşağıda doğru itin ve doğru kitlendiğinden emin olun. Son olarak sıçratma önleyici kapağı takın ve mikseriniz çalıştırılmaya hazır olacaktır.
- Cihazın güç kablosunu prize takın. Hız kontrol düğmesinden uygun hızı ayar seviyesine getirerek mikserinizi çalıştırın.
- Mikserinize gıda ilave etmek istediğiniz malzemeleri kapağını açmadan pratik bir şekilde sıçratmayı önleyen kapağın üzerindeki boşluktan ekleyebilirsiniz.
- Karıştırma işleminiz bittüğünde mutlaka cihazı hız kademesinden "0" konumuna getirin ve cihazı fişten çekin.





Retro





# TEMİZLİK VE BAKIM





- Temizlemeden önce her zaman mikserinizin fişini prizden çektiğinizden emin olun.
- Kullanım sonrası cihazın soğumasını bekleyin.
- Cihazı asla suya daldırmayın.
- Cihazın dışını temizlemek için nemli bir bez kullanın.
- Karıştırma haznesi temiz, sıcak, sabunlu suyla yıkanmalı, durulanıp, iyice kurulanmalıdır.
- Aparatlar bulaşık makinesi kullanımına uygun değildir. Temiz, sıcak, sabunlu suyla yıkanmalı, durulanıp, iyice kurulanmalıdır.



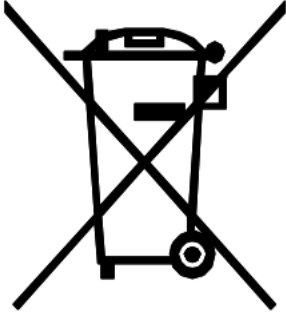

## ÇEVRE DOSTU İMHA

Çevre korumasına yardımcı  
olabilirsiniz!

Lütfen yerel düzenlemelere uymayı  
unutmayın; çalışmayan elektrikli  
ekipmanları uygun bir atık imha  
merkezine teslim edin.



Retro





# Retro

## STAND MIXER USER MANUAL





PLEASE READ BEFORE USE

## SAFETY WARNINGS

Thank you for choosing the PORLAND RETRO STAND MIXER. Our product is designed and manufactured to provide you with long-lasting, trouble-free service. These instructions are organized to ensure the device is used correctly and safely.

*When using an electrical appliance, always adhere to basic safety precautions, including the following*

- Do not immerse the appliance, its cord, or plug in water or any other liquid.
- If there is an incompatibility between the device's plug and the socket, have a qualified person replace the socket with the appropriate type.
- Exercise caution and discretion when the device is accessible to small children.





- Check if the mains voltage corresponds with the voltage stated on the device's rating plate. Only connect the device to an efficiently earthed power outlet with a minimum capacity of 10A. The manufacturer is not responsible for potential accidents due to inadequate earthing.
- Do not use the device outdoors.
- The device is designed for personal indoor use at altitudes not exceeding 2000m.
- When not in use, unplug the device from the electrical outlet and turn it off. Avoid leaving the device connected to the power supply unnecessarily.
- All servicing, other than daily maintenance and cleaning performed by the user, should be done by an authorized service center.





- For safety, only use accessories and spare parts designed for this device by the manufacturer.
- Do not use the device if it is not functioning properly or if it has been damaged. Contact an authorized service center in such cases.
- Place the device away from water taps, sinks, and heat sources on a flat surface.
- Do not install the device in environments where the temperature can drop to 0°C or below.
- This device is designed solely for home and office use. Using it for other purposes can cause damage.
- To disconnect, turn the On/Off switch to the “Off” position, unplug it from the wall socket, always hold the plug, not the cord, when unplugging.
- Close supervision is necessary when any appliance is used by or near children.





## **Attention!**

**Failure to follow these warnings could result in injury or damage to the device. The manufacturer is not liable for potential damages arising from improper, incorrect, or unreasonable use.**

- This device can be used by children aged 8 years and above and by persons with reduced physical, sensory, or mental capabilities, or lack of experience and knowledge, under supervision and with instruction on safe use and understanding of the hazards. Children should not play with the device. Do not allow children under 8 years or unsupervised children to perform cleaning and maintenance. Keep the device and cord out of reach of young children.



Retro





# USING THE MIXER





Failure to adhere to these rules may result in injury or damage to the device. The manufacturer is not responsible for damage due to improper, incorrect, or unreasonable use.

- Place the device on a flat working surface away from water taps, sinks, and heat sources.
- Do not install the device in environments where the temperature can drop to 0°C or below.
- After placing the device on the countertop, ensure there is a gap of about 5 cm between the device surfaces and side and back walls, and at least 20 cm of free space above the mixer.
- Unplug the device when not in use and before cleaning or removing and attaching parts. Allow the device to cool down before cleaning.





- This device is intended only for home and office use. Do not use it for any other purpose to prevent damage.
- To disconnect, turn the On/Off switch to the “Off” position, unplug it from the wall socket, and always hold the plug, not the cord, when unplugging.
- NEVER immerse the main body of the mixer in water or any other liquid. Unplug the device immediately if it gets wet in any way.
- Always unplug the mixer after use, before attaching or detaching accessories, and before conducting maintenance and cleaning.
- Do not operate the mixer with the whisks or dough hooks in the air or outside the bowl; this could damage the device.





- Avoid touching moving parts while the mixer is operating. Keep hands, hair, clothing, and utensils away from the device.
- Do not overload the mixer with food.
- Do not use the mixer to mix flammable or combustible materials.



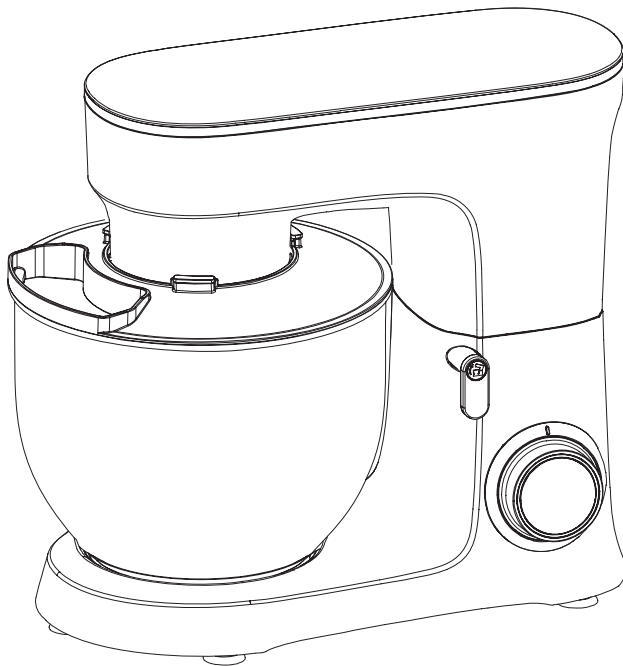



Retro





# DEVICE INTRODUCTION



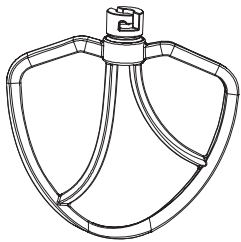

## USING THE ATTACHMENTS;

**Beater:** Use for normal to heavy mixtures, like cakes, cookies, frostings, pastry, etc.

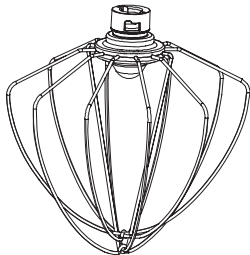

**Whisk:** Use for mixtures that need to incorporate air, like eggs, egg whites, heavy cream, etc

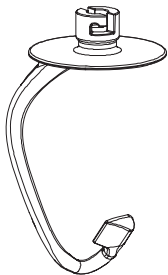

**Dough Hook:** Use for mixing and kneading yeast dough, like bread, pizza dough, and rolls.



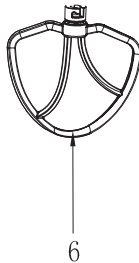
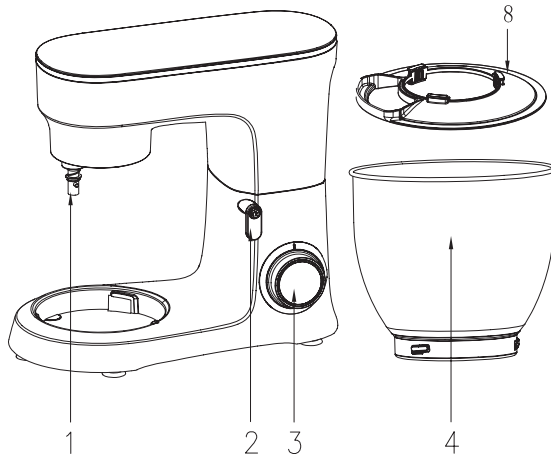

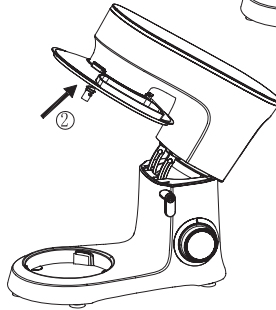
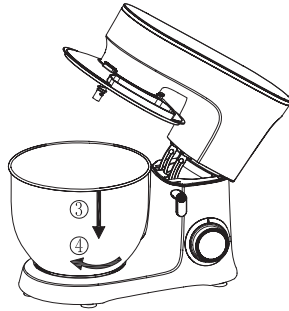
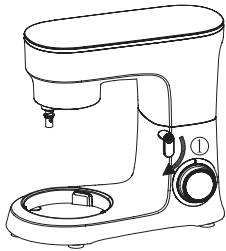

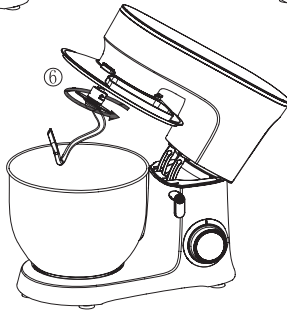
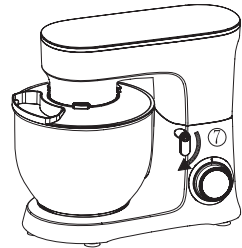
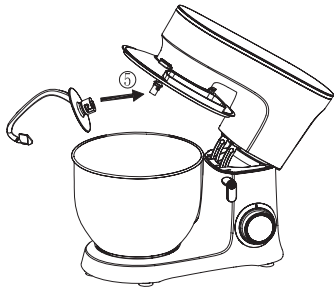



## USING YOUR STAND MIXER

### Before first use

Clean all parts of the stand mixer before the first use.

- Place your stand mixer on a flat, clean, and dry surface, then plug it into an outlet.
- Turn the motor head lift lever clockwise (to the left) to raise the motor head.
- Attach the desired accessory to the attachment hub at the bottom of the motor head and turn it clockwise to secure.
- Place the mixing bowl in position, then twist it in the direction indicated on the mixer to lock it in place.
- Lower the motor head by turning the lift lever clockwise and ensure it locks correctly. Attach the pouring shield and your mixer is ready to use.
- Plug in the appliance. Set the desired speed using the speed control dial to start the mixer.





- You can add ingredients through the pouring shield's chute while the mixer is running.
- Once mixing is done, turn the speed control to the '0' position and unplug the mixer.





Retro





# CLEANING AND MAINTENANCE





- Never immerse the mixer in water.
- Use a damp cloth to clean the exterior.
- The mixing bowl should be washed with warm soapy water, rinsed well, and dried.
- The accessories are not dishwasher safe. They should be washed with warm soapy water, rinsed well, and dried.





### **ECO-FRIENDLY DISPOSAL**

This appliance is composed of recyclable materials compliant with the WEEE Directive. Do not dispose of it with household waste. Please contribute to its recycling by taking it to a designated collection point.





# CE

## ÜRETİCİ

**PORLAND Porselen San. ve Tic. A.Ş**

Büyükdere Caddesi No: 245 Uso Center Kat :12 D: 43/46  
Maslak/Sarıyer/İstanbul

## İTHALATÇI

**İmge Ev ve Yaşam Gereçleri A.Ş**

Büyükdere Caddesi No: 245 Uso Center Kat :12 D: 43/46  
Maslak/Sarıyer/İstanbul

